

OLYMPUS

Industrial Videoscope

IPLEX NX

IPLEX

The Expert's Choice for Visual Inspection

Great images get great results



Aviation



Power Generation



Oil / Gas / Chemicals



Automotive



The IPLEX NX: Olympus' Most Advanced Videoscope for Critical Inspection Tasks

Olympus' IPLEX NX combines the high-quality images available in a videoscope with an intuitive user interface, ergonomic design, and durability for efficient inspections in any environment. With clear, bright images and powerful measurement features, the IPLEX NX is built to exceed your expectations.

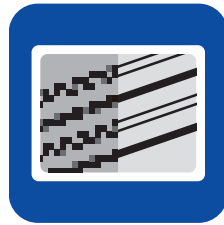

High-Quality Images

Advanced digital imaging technology combines with Olympus optical expertise to provide vivid images, displayed on a large 8.4-inch touch screen that is clear and readable in any light. Revealing even the subtlest of defects, with bright, high-quality images, the IPLEX NX is optimized to help inspectors find flaws that might otherwise be missed.

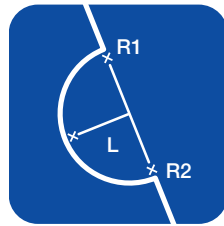

Expanded Measurement Capabilities

Experience the easy-to-use Advanced Stereo Measurement feature with expanded inspection coverage for fast, efficient inspections. Olympus' unique multi Spot-Ranging provides real-time tip to target measurements for enhanced inspection accuracy.



Improved Inspection Efficiency

The IPLEX NX is designed to maximize inspection productivity. IPLEX NX fits in most tight spaces, with flexible positioning, clear viewing, optimized operation, and easy access to controls. Moreover, IPLEX NX offers a range of interchangeable scopes, while TrueFeel electric scope tip articulation provides precise control, Ghost Image Function compares past and present inspections, and the flexible Tapered Flex tube combines smooth insertion and maneuverability. Optional InHelp inspection assist software and optional Wi-Fi simplify inspecting, reporting, and data archiving.

High-Quality Images for Clear Visualization

The IPLEX NX is engineered to deliver high-resolution images. Its reliable image quality enables users to clearly identify trouble spots and defective areas, so inspectors can make correct judgments involving crucial systems and technologies.

ACTUAL SIZE





Exceptional Brightness and Image Quality

View target areas clearer than ever before with IPLEX NX. A trio of enhancements — improved high-resolution CCD technology, intensely-bright laser diode illumination, and the innovative PulsarPic processor — achieve unprecedented image quality that is four times brighter than a conventional model. Inspection targets are brightly illuminated even in large, wide spaces.

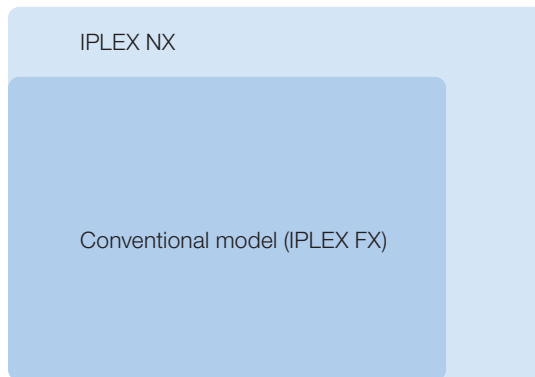

Comparison of image sizes

Featuring an 8.4-inch monitor, the largest in the IPLEX series, IPLEX NX can display an image that is 1.7 times larger in area than that of a conventional 6.5-inch monitor. In addition, the daylight view monitor of clear type featuring displays clear images even under bright sunlight.

Conventional model

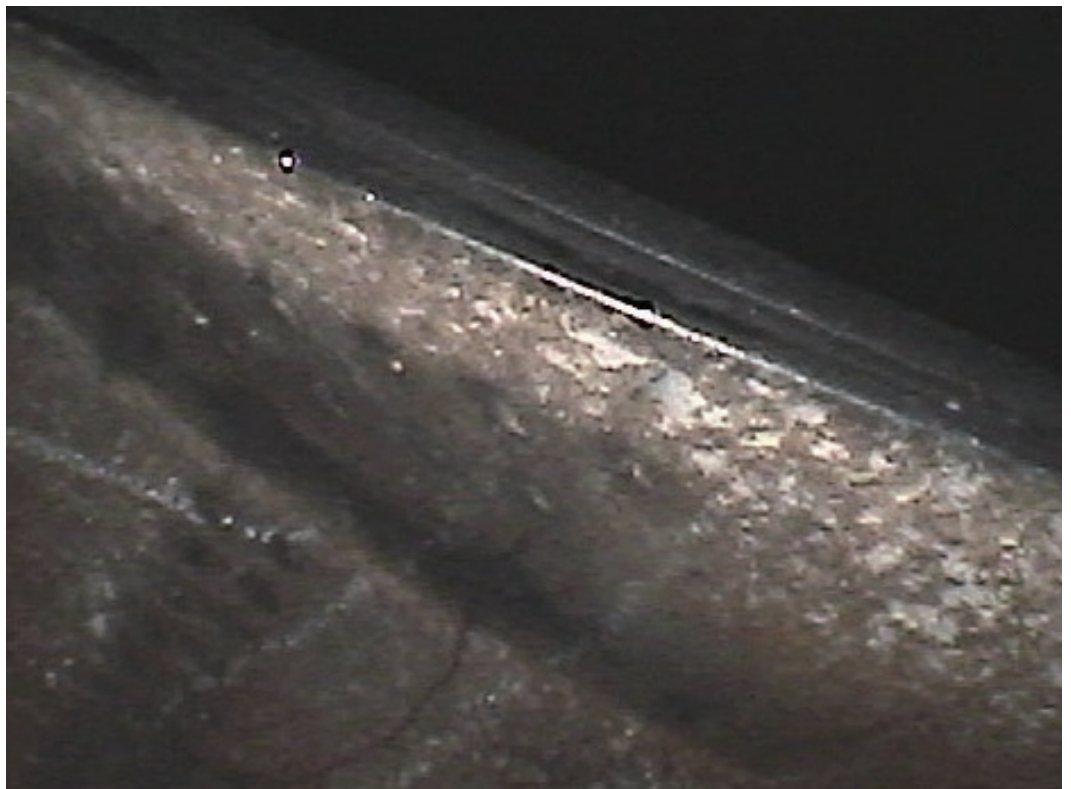

Get a Clearer Look

Bright, clear images help you scrutinize the subtlest defects in the darkest or most reflective places, and over wide areas. The videoscope's sophisticated technology means you get the high-quality images you need for fast, precise inspections.

Image Quality Comparison

Melted material

IPLEX NX



Exceptional Resolution
Displays Small Faults

Conventional model (IPLEX FX)



Turbine



Bright Illumination
Lights Large Cavities

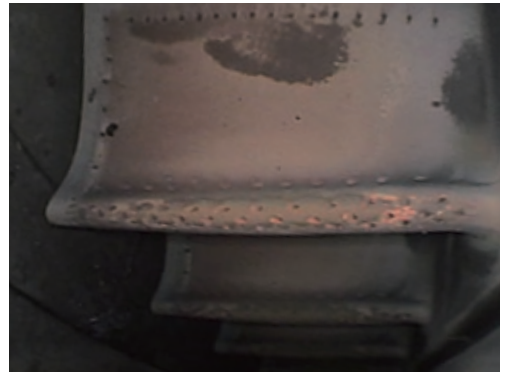

Welding

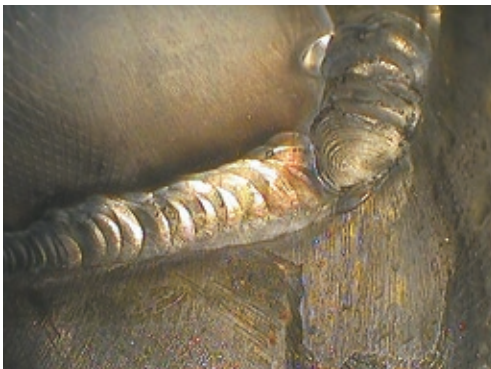

Exceptional Color Reproduction
Delivers Vivid Details



Combustion chamber



Advanced Noise Reduction
Refines Busy Images



HD RVI with 3D Has Arrived

Be confident in your measurements. Easy-to-use 3D modeling and advanced tools expand your capabilities, enabling you to make reliable measurements.

Measure with Confidence Using 3D Modeling

Choosing the right measurement point is now even easier. 3D modeling enables you to see the details of what you're inspecting from multiple angles, making it easier to specify the exact location of your measurement points.

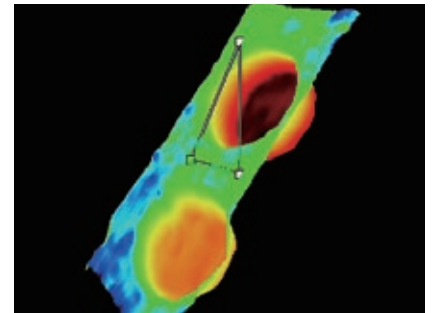
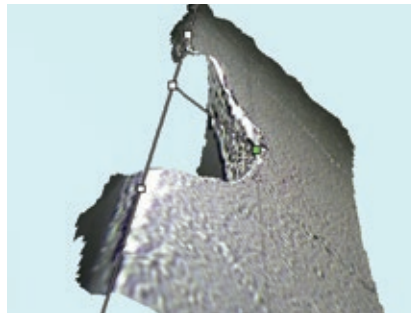
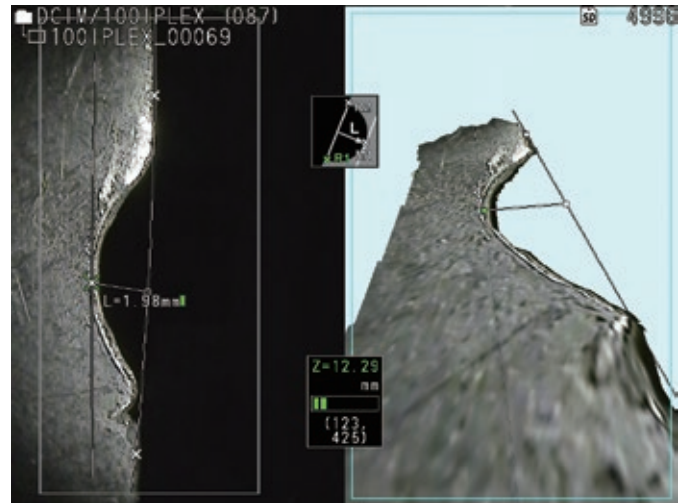

Instantly Confirm Measurement Objects

- 3D modeling enables you to clearly see the shape and complexity of your target
- Precisely designate your measurement points for faster inspections
- Choose the right points the first time to minimize the need to re-measure

Set Reference Lines Where You Want Them

- 3D images facilitate reliable reference lines on difficult components, such as the edge of a turbine blade
- Reduce the chance of misalignment

Make Confident Depth Measurements

- Confirming the reference plane is intuitive
- Specify your measurement points with confidence for reliable depth measurements

Super Wide Field Stereo Measurement

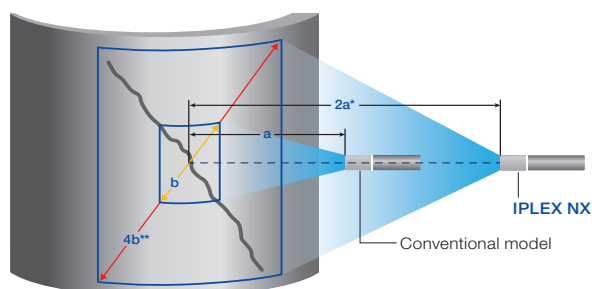

The videoscope's advanced optical system and image enhancing algorithms deliver an inspection area 4 times larger and depth of field 2 times larger than previous systems. The stereo measurement function supplies 3D space information for specific points in an image. Through precise triangulation, users can determine the length, depth, and area of a defect. These features enable inspectors to detect small flaws at very close range that may have been previously missed.

* Even if the measurement is performed from two times further away, IPLEX NX is as precise as a conventional model.

** When using a Ø6.0mm scope with direct-viewing stereo optical adaptor, the diagonal length of the inspection area of IPLEX NX is almost 4 times of the conventional model.

Note: Actual viewing angle is wider than shown in this illustration.

Improved Inspection Efficiency

The IPLEX NX is simple to operate and user friendly. Even during long inspections, the NX delivers user comfort and maneuverability thanks to interchangeable scope units and TrueFeel scope tip articulation.

Multi-position Design

The IPLEX NX can be configured six different ways to maximize user comfort. The monitor can be positioned to maintain comfort when using the IPLEX NX in different environments. The configuration can be changed to accommodate any inspection situation. Add the optional handheld remote control unit for the utmost light and tactile control.



Internal Working Channel Scope

With similar functionality and capability as a standard insertion tube, the working channel scope is a useful backup while offering the versatility to use it to detect and remove foreign object debris (FOD). Don't get caught with a plane on the ground—add a working channel scope to your kit, so it's there when you need it.

- Interchangeable 6.2 mm (0.24 in.) diameter scope with internal working channel
- Six available internal retrieval tools

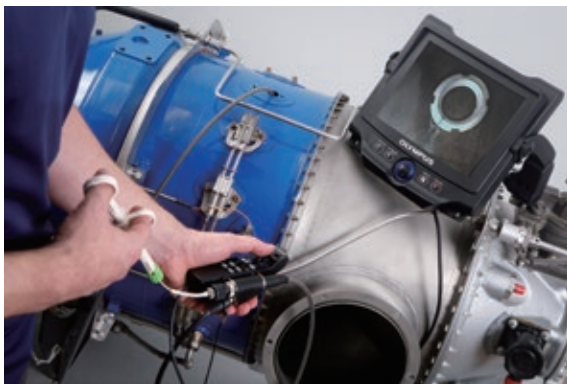

Internal working channel scope with retrieval tool

Interchangeable scope units

Choose the right parts for the right job. A single NX videoscope can be configured for varied inspections, with $\varnothing 4.0$ mm scope (lengths 3.5 m and 5.0 m), $\varnothing 6.0$ mm scope (lengths 3.5 m, 5.0 m, and 7.5 m), and $\varnothing 6.2$ mm scope (length 3.5 m).



TrueFeel

A newly employed electric motor further enhances TrueFeel operation, achieving rapid and responsive movement. Inspectors can flexibly control the scope through lightweight, comfortable operation that also lessens user fatigue.



IPLEX NX Dimensions and Accessories

Dimensions

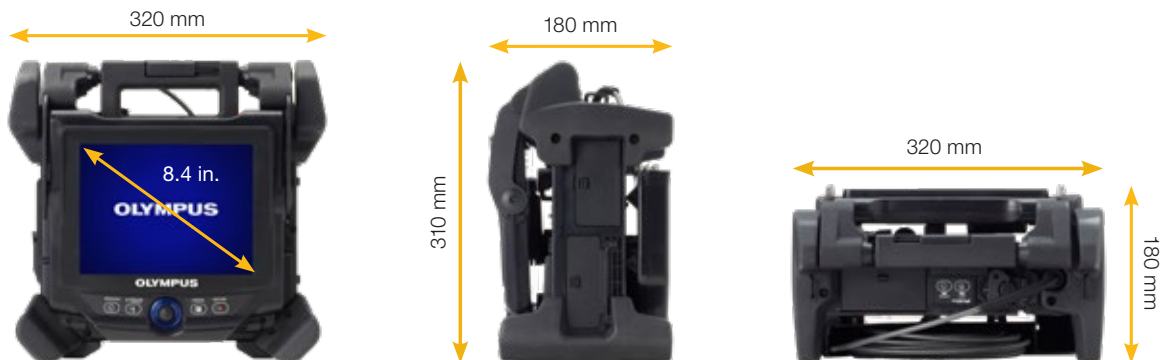

Accessories

Remote Control Unit

MAJ-2260

This small handheld remote controller provides adjustment of brightness and zooming, display switching, recording, joystick operation, spot ranging, activation of measurement function, etc.



Lithium-ion Battery

NP-L7S

Battery Charger

JL-2PLUS/OL-0 (115 V type)

JL-2PLUS/OL-1 (220 V type)

Each battery provides long-lasting operation. With a full set of batteries, the IPLEX NX system is ready for inspection virtually anywhere, anytime.



Long LCD Cable

MAJ-2261

This 2-meter-long LCD cable enables inspection while placing the main unit and the monitor at a distance.



Optical Adaptors

The IPLEX NX has a comprehensive range of tip adaptors to meet the optical requirements of any application.

Smart Tip

*Smart Tip is a function to recognize the optical adaptor automatically.



Rigid Sleeve Sets

MAJ-1253

(for 6.0 mm/6.2 mm insertion tube)

MAJ-1737

(for 4.0 mm insertion tube)

Sets are available for 6.0 mm/6.2 mm and 4.0 mm scopes. Each set consists of three rigid sleeves of 250 mm, 340 mm and 450 mm length.



Scope Case

MAJ-2262

(for 4.0 mm/6.0 mm insertion tube)

MAJ-2501

(for 6.2 mm insertion tube)

Interchangeable scope units can be safely stowed and carried comfortably to inspection venues.



Internal Retrieval Tools

Six internal retrieval tools enable you to remove foreign objects, retrieve dropped items, and perform hook-and-drag inspections inside aircraft engines.



Alligator
MAJ-1354



Basket
MAJ-1355



Snare
MAJ-1353



Grasper
MAJ-1356



Magnet
MAJ-1357



Hook
MAJ-1245

Efficiency throughout the Inspection Process

The IPLEX NX realizes optimal efficiency in each step of inspection from start to finish.



Portability is a true advantage in various inspection settings. You can easily transport the IPLEX NX to your inspection location in its compact carrying case.



Reliable and durable, the IPLEX NX complies with stringent military standards including MIL-STD-810G/461F and IP55 for protection against water and dust. Insertion tube air temperature resistance (up to 100 °C) means you can get to work faster rather than wait for cool down.



Touch screen with icon-based menus enables you to quickly choose the correct options. You can control the scope tip through joystick operation.



Multi-Position Design lets you easily configure the IPLEX NX depending on the conditions of the inspection venue.



Interchangeable scope units are available in Ø4.0 mm scope (lengths 3.5 m and 5.0 m) and Ø6.0 mm scope (lengths 3.5 m, 5.0 m, and 7.5 m). A single NX videoscope system can be configured for varied inspections.



Tapered Flex tube combines maneuverability with optimized rigidity and flexibility for smooth scope insertion, enabling you to reach target areas quickly and easily.





Ghost Image function

assists inspection comparisons. Images stored on IPLEX NX can be superimposed on live images to contrast past and present conditions.

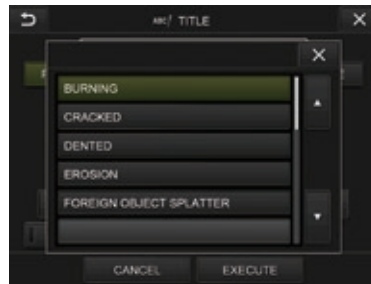

InHelp inspection assist software

simplifies data input and management, improving efficiency, simplifying inspections, and organizing stored images. Optional data sets provide you standard inspection structure.

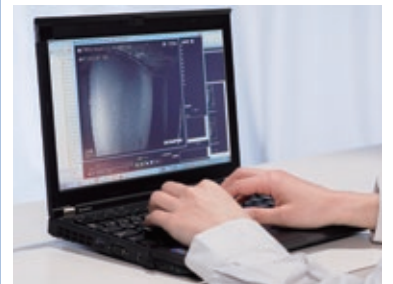

InHelp inspection assist software (for reporting)

makes your routine work simple and easy. With optional report templates matched to data sets, you can generate detailed reports with a few clicks.



TrueFeel scope tip articulation gives you light-touch command for faster, easier inspections. Proprietary technology and precise tuning facilitate responsive bending for optimal target approach. In addition to normal mode, choose from three articulation speeds in fine mode.



Enable multiple experts to **monitor remote procedures at the same time** by using an SD card* equipped with commercially available wireless LAN, enhancing analysis speed and inspection accuracy.

*Confirmed with Kioxia FlashAirWireless LAN SD card (operability confirmed)



IPLEX NX Features and Specifications

SCOPE UNIT

Model No.	IV9435N	IV9450N	IV9635N	IV9650N	IV9675N	IV9635X1N
Insertion tube	Scope diameter ϕ 4.0 mm					
	Scope length 3.5 m		5.0 m		3.5 m	
	Exterior High - durability tungsten braid					
Optical system	Tube flexibility Uniform stiffness					
	Tapered Flex insertion tube with flexibility gradually increasing toward the distal end					
Optical system	Field of view					
	Direction of view Selectable by optical adaptor. Adaptor for Stereo measurement attachable					
Illumination High - intensity laser diode						
Articulation Section	Articulation angle up/down/right/left 130°		180°		150°	
	Articulation operation TrueFeel scope tip articulation with electronic power-assisted					

BASE UNIT

Dimensions (W x H x D)		320 x 310 x 180 mm					
Weight		5.4 kg					
Approx. system weight (with battery and SDHC card)		7.1 kg		7.2 kg		7.3 kg	
LCD monitor		8.4-inch daylight-view, touch screen LCD, clear type					
Input/Output Terminal	Input terminal	S-Video					
	Output terminal	VGA					
USB connector		Type A connector, Version 2.0 standards					
Power supply		Battery: 14.8 V nominal, approx. 100-minute operating time. AC power: 100 V to 240 V, 50/60 Hz (with supplied AC adaptor)					
Recording media		SDHC card and USB flash memory (Still image recording only)					
Still image recording	Resolution	H768 x V576 (Pixel)		H1024 x V768 (Pixel)		H768 x V576 (Pixel)	
	Recording format	Compressed JPEG format					
Video recording	Resolution	H768 x V576 (Pixel)		H1024 x V768 (Pixel)		H768 x V576 (Pixel)	
	Recording format	MPEG-4 AVC (H.264) format, Windows Media Player compatible					
Stereo measurement	Distance	Distance between two points					
	Point-to-line	Perpendicular distance between a point and a user-defined line					
	Depth	Orthogonal depth/height distance between a point and a user-defined plane					
	Area/Lines	Multiple point circumference and area measurement					
3D Modeling		Live cross section, X/Y/Z-axis rotation, 2x Color mapping mode					
Scaler measurement		Distance between two points based on a known measurement in the same plane					

OPTICAL ADAPTOR SPECIFICATIONS

		OPTICAL ADAPTOR VARIATION							
		ϕ 4.0 mm Optical Adaptors							
		AT80D/FF-IV94N	AT120D/NF-IV94N	AT120D/FF-IV94N	AT100S/NF-IV94N	AT100S/FF-IV94N	AT70D/70D-IV94N	AT50S/50S-IV94N	
Optical system	Field of view	80°	120°	120°	100°	100°	70°/70°	50°/50°	
	Direction of view	Forward	Forward	Forward	Side	Side	Forward	Side	
	Depth of field*1	35 to ∞ mm	2 to 200 mm	17 to ∞ mm	2 to 15 mm	8 to ∞ mm	5 to 200 mm	3 to 150 mm	
Distal end	Outer diameter*2	ϕ 4.0 mm	ϕ 4.0 mm	ϕ 4.0 mm	ϕ 4.0 mm	ϕ 4.0 mm	ϕ 4.0 mm	ϕ 4.0 mm	
	Distal end*3	20.1 mm	20.2 mm	20.1 mm	22.9 mm	22.9 mm	22.3 mm	26.7 mm	
		ϕ 6.0 mm Optical Adaptors							
		AT50D/FF-IV96N	AT80D/FF-IV96N	AT120D/NF-IV96N	AT120D/FF-IV96N	AT120S/NF-IV96N	AT120S/FF-IV96N	AT90D/90D-IV96N	AT70S/70S-IV96N
Optical system	Field of view	50°	80°	120°	120°	120°	120°	90°/90°	70°/70°
	Direction of view	Forward	Forward	Forward	Forward	Side	Side	Forward	Side
	Depth of field*1	50 to ∞ mm	20 to ∞ mm	7 to 300 mm	19 to ∞ mm	4 to 150 mm	20 to ∞ mm	5 to 250 mm	4 to 250 mm
Distal end	Outer diameter*2	ϕ 6.0 mm	ϕ 6.0 mm	ϕ 6.0 mm	ϕ 6.0 mm	ϕ 6.0 mm	ϕ 6.0 mm	ϕ 6.0 mm	ϕ 6.0 mm
	Distal end*3	21.3 mm	21.3 mm	21.4 mm	21.4 mm	26.6 mm	26.6 mm	25.0 mm	31.2 mm
		ϕ 6.2 mm Optical Adaptors							
		AT80D-IV96X1N	AT120D/NF-IV96X1N	AT120D/FF-IV96X1N	AT80S-IV96X1N	AT120S-IV96X1N	AT70D/70D-IV96X1N	AT60S/60S-IV96X1N	
Optical system	Field of view	80°	120°	120°	80°	120°	70°/70°	60°/60°	
	Direction of view	Forward	Forward	Forward	Side	Side	Forward	Side	
	Depth of field*1	35 to ∞ mm	2 to 200 mm	17 to ∞ mm	30 to ∞ mm	8 to ∞ mm	5 to 200 mm	3 to 150 mm	
Distal end	Outer diameter*2	ϕ 6.2 mm	ϕ 6.2 mm	ϕ 6.2 mm	ϕ 6.2 mm	ϕ 6.2 mm	ϕ 6.2 mm	ϕ 6.2 mm	
	Distal end*3	20.6 mm	20.6 mm	20.6 mm	24.4 mm	24.4 mm	22.7 mm	28.3 mm	

*1. Indicates the viewing distance with optimal focus. *2. The adaptor can be inserted into a ϕ 4.0 mm, ϕ 6.0 mm and ϕ 6.2 mm hole when it is mounted on the scope. *3. Indicates the length of the rigid portion at the scope's distal end when mounted.

OPERATING ENVIRONMENT

Operating temperature	Insertion tube	In air : -25 to 100 °C In water : 10 to 30 °C
	Other parts	In air : -21 to 49 °C (with battery) In air : 0 to 40 °C (with AC power adaptor)
Relative humidity	All parts	15 to 90 %
Liquid resistance	All parts	Operable when exposed to machine oil, light oil or 5 % saline solution.
Waterproofing	Insertion tube (excluding IV9635X1N)	Operable under water with viewing tip adaptor attached. Not operable underwater with stereo measurement tip adaptors. IV94 series — Up to an equivalent to 5.0 m (16.5 ft) in depth. IV96 series — Up to an equivalent to 7.5 m (24.6 ft) in depth.
	Other parts	Operable in blowing rain conditions (battery compartment must be closed). Not operable under water.

MIL-STD COMPLIANCE

The operating environment performance is confirmed by the following MIL-STD-810G and MIL-STD-461/G. No warranty is given as to damage-free under any conditions. Please ask Olympus sales representative for details.

Type	Method
Low atmosphere	MIL-STD-810G, Method 500.6
High temperature	MIL-STD-810G, Method 501.6
Cold temperature	MIL-STD-810G, Method 502.6
Rain and Blowing rain	MIL-STD-810G, Method 506.5
Humidity	MIL-STD-810G, Method 507.5
Salt Fog	MIL-STD-810G, Method 509.5
Blowing dust	MIL-STD-810G, Method 510.5
Explosive Atmosphere	MIL-STD-810G, Method 511.5
Vibration	MIL-STD-810G, Method 514.6
Shock	MIL-STD-810G, Method 516.6
Icing/Freezing Rain	MIL-STD-810G, Method 521.3
Conducted susceptibility Power leads	MIL-STD-461G, CS101 (IV9635X1N, IV9435N and IV9450N only)
Conducted susceptibility Bulk cable injection	MIL-STD-461G, CS114 (IV9635X1N, IV9435N and IV9450N only)
Conducted susceptibility Damped sinusoidal transient	MIL-STD-461G, CS116 (IV9635X1N, IV9435N and IV9450N only)
Radiated emission Magnetic Field	MIL-STD-461G, RE101 (IV9635X1N, IV9435N and IV9450N only)
Radiated emission Electric Field	MIL-STD-461G, RE102 Below Deck (IV9635X1N, IV9435N and IV9450N only)
Radiated susceptibility Magnetic Field	MIL-STD-461G, RS101 (IV9635X1N, IV9435N and IV9450N only)
	MIL-STD-461G, RS103 Above Deck (IV9635X1N, IV9435N and IV9450N only)
Electromagnetic Interference (EMI)	MIL-STD-461G, RS103 Above Deck (excluding IV9635X1N, IV9435N and IV9450N)



OLYMPUS

OLYMPUS CORPORATION
www.olympus-ims.com

For enquiries - contact
www.olympus-ims.com/contact-us

- OLYMPUS CORPORATION is ISO14001 certified.
- OLYMPUS CORPORATION is ISO9001 certified.

*This product is designed for use in industrial environments for the EMC performance. Using it in a residential environment may affect other equipment in the environment.
*Specifications and appearances are subject to change without any notice or obligation on the part of the manufacturer.
*All company and product names are registered trademarks and/or trademarks of their respective owners.